

# DESTINATION ABU DHABI

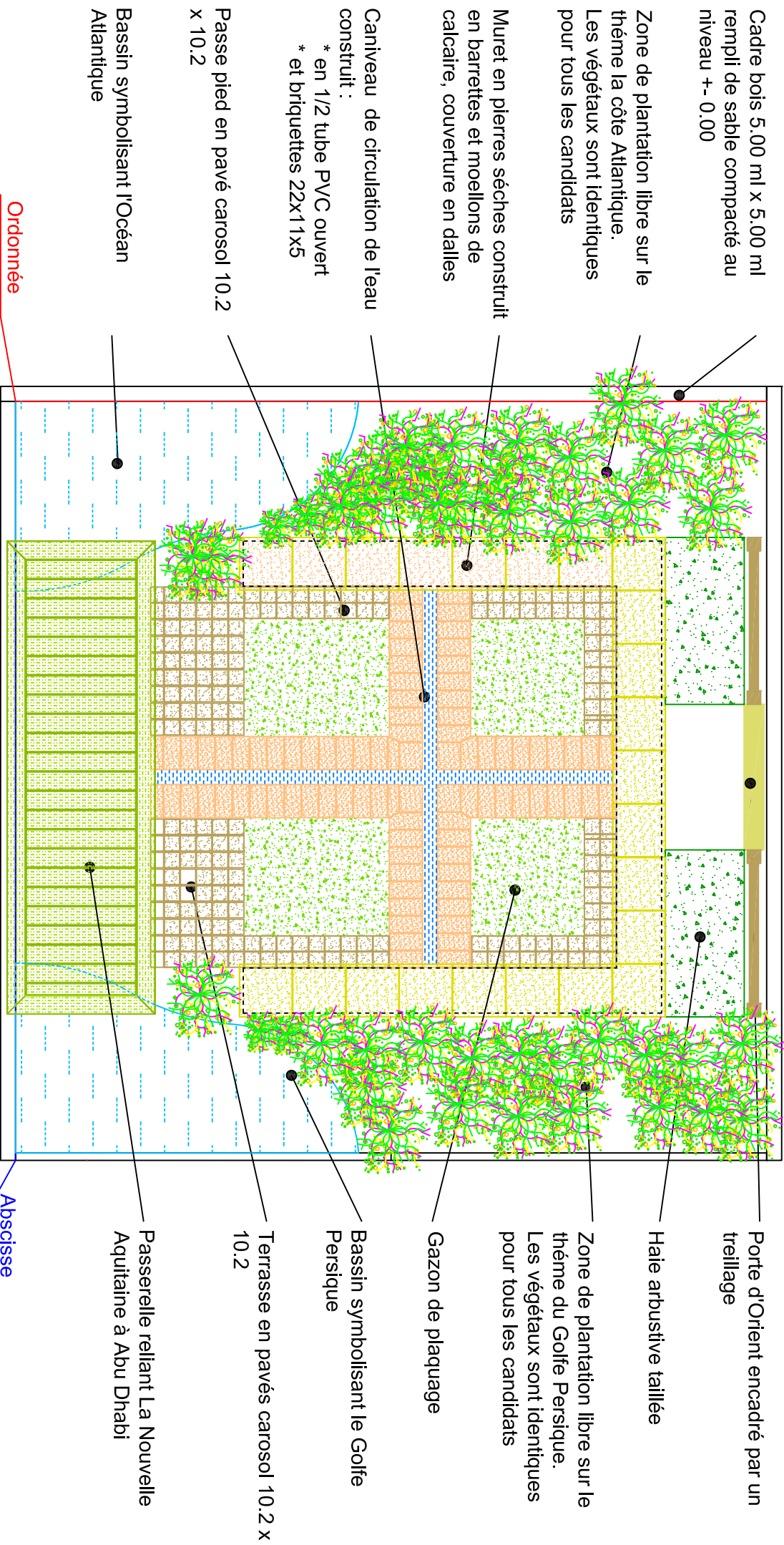

- PLAN GENERAL -

INDICE 7

07 - 11 - 2016

**Olympiades Nationales Bordeaux 2017**  
- Jardiniers Paysagistes -

Unités: Plan / mm - Altimétrique / ml

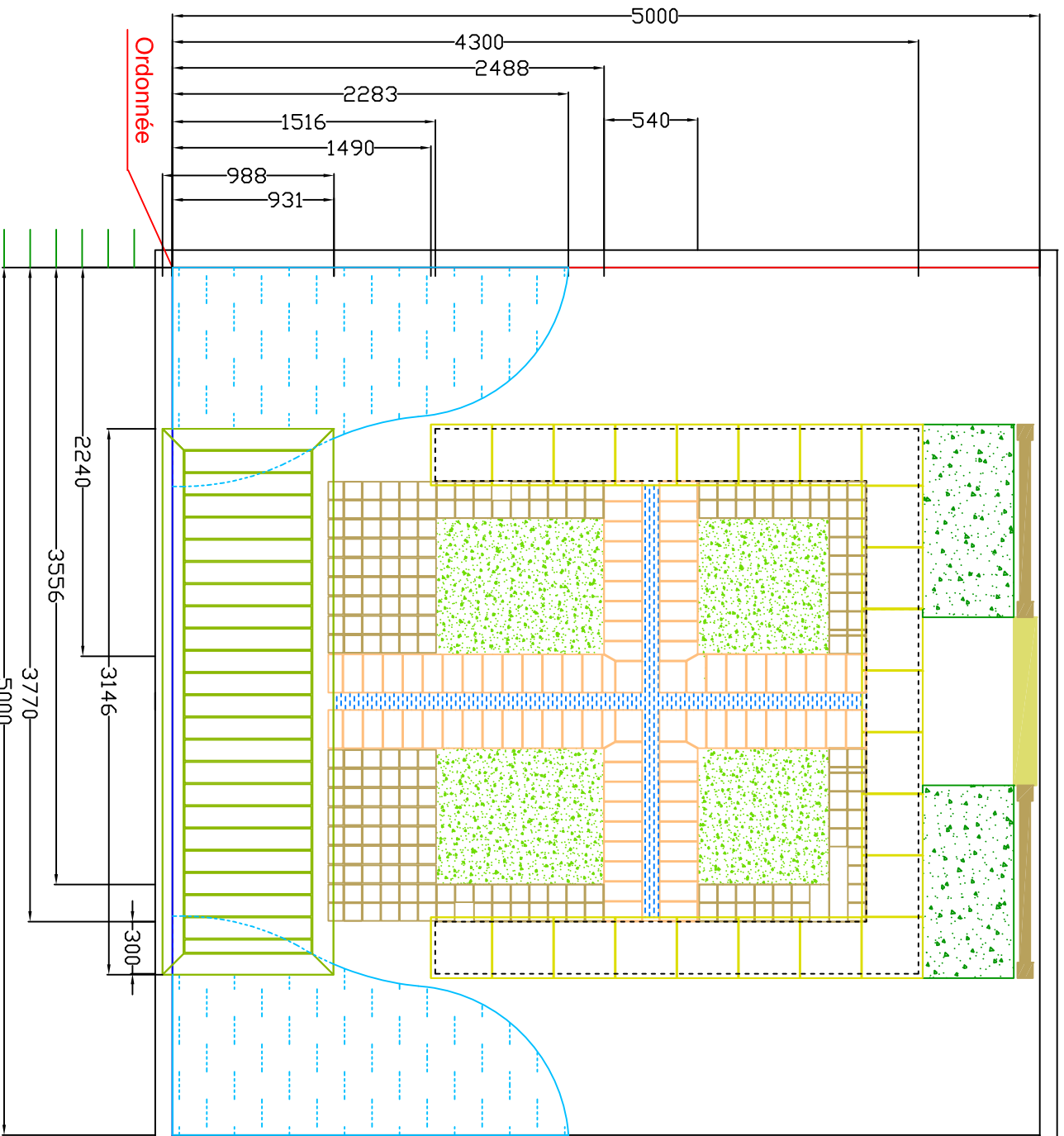

- IMPLANTATION PLANIMETRIQUE -

INDICE 7

07 - 11 - 2016

# Olympiades Nationales Bordeaux 2017

## - Jardiniers Paysagistes -

Unités: Plan / mm - Altimétrique / ml



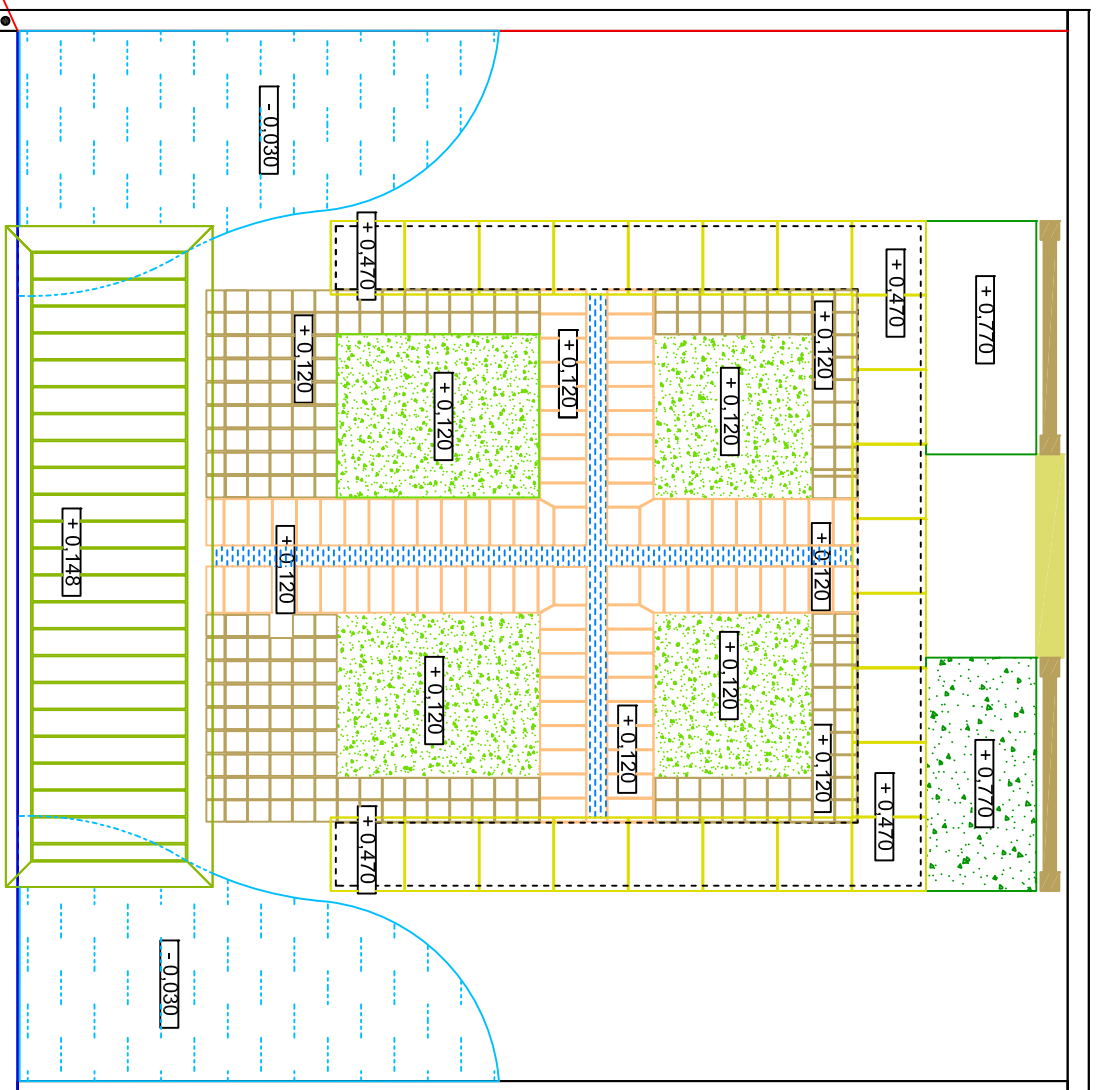

Ordonnée  
 POINT  
 DE  
 REFERENCE  
 +0.000

Abscisse

- COTATION ALTIMETRIQUE -

INDICE 7

07 - 11 - 2016

**Olympiades Nationales Bordeaux 2017**  
**- Jardiniers Paysagistes -**

Unités: - Altimétrie / ml -



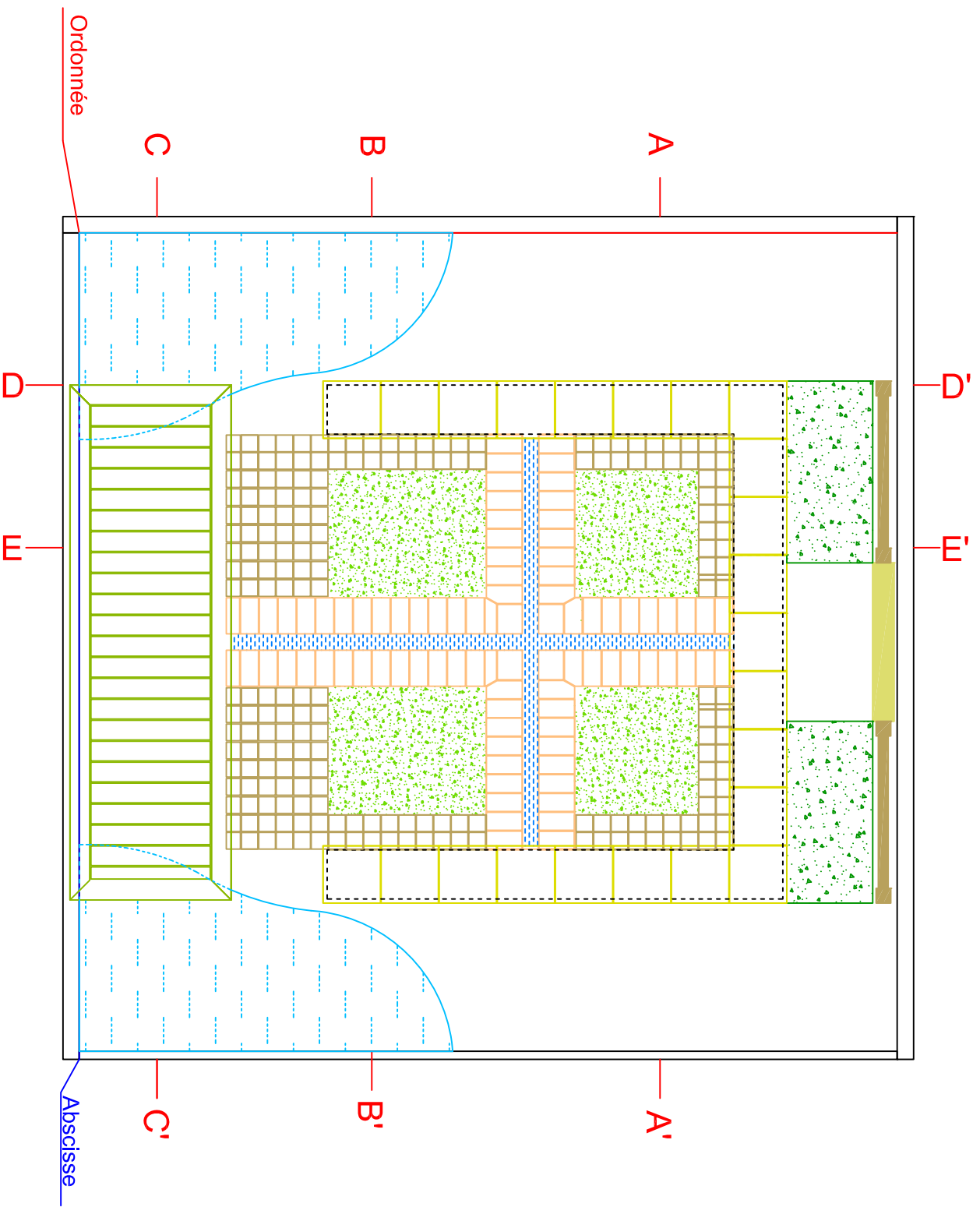

- PLAN POSITIONNEMENT COUPE -

INDICE 7

07 - 11 - 2016

# Olympiades Nationales Bordeaux 2017

## - Jardiniers Paysagistes -

Unités: Plan / mm - Altimétrique / ml



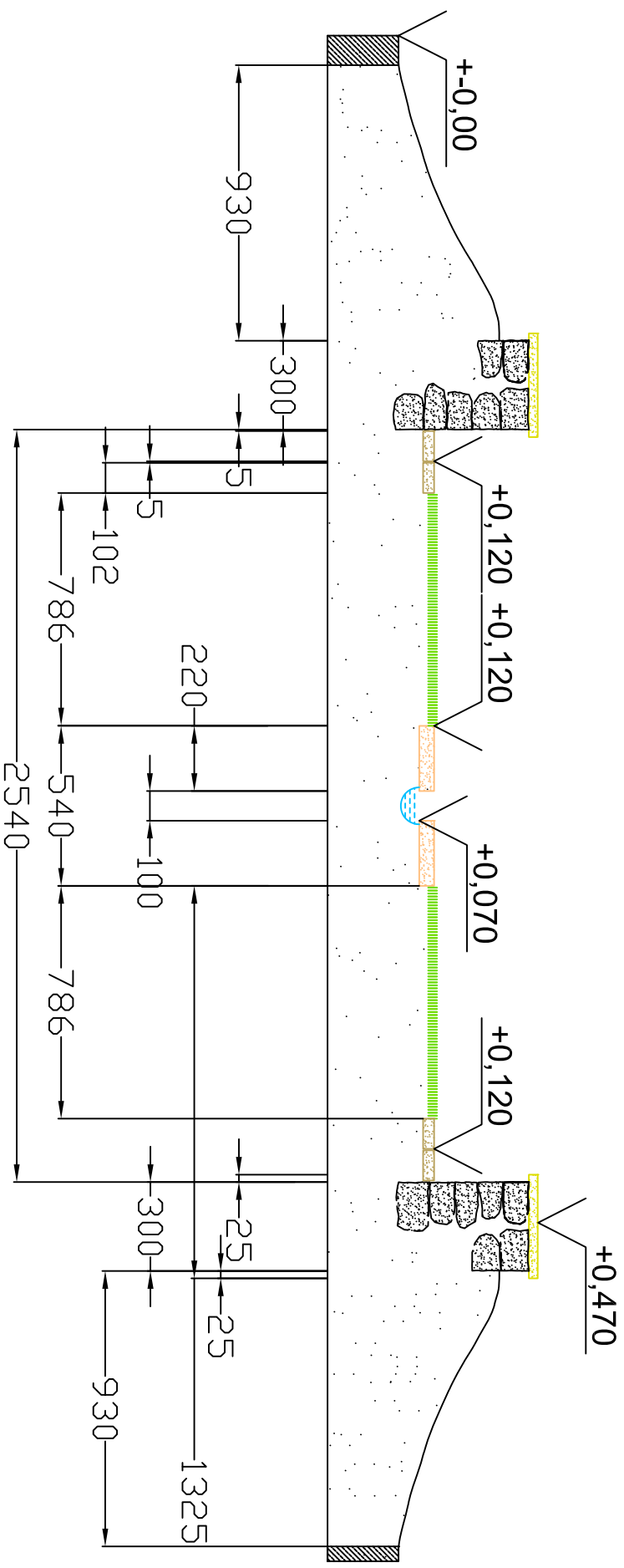

- COUPE AA' -

INDICE 7

07 - 11 - 2016



Unités: Plan / mm - Altimétrique / ml

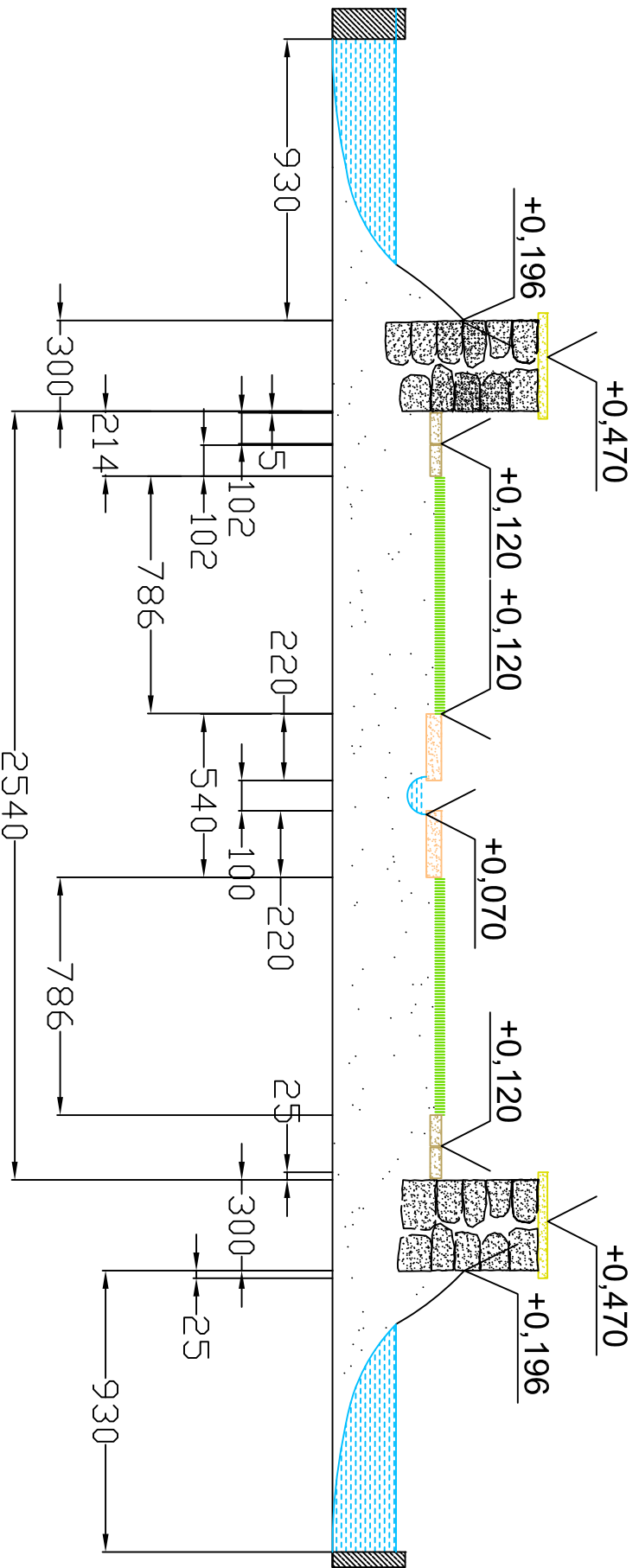

-COUPE BB' -

INDICE 7 07 - 11- 2016

**Olympiades Nationales Bordeaux 2017**  
**- Jardiniers Paysagistes -**



Unités: Plan / mm - Altimétrique / ml

chaque jardin compte

LES ENTREPRISES DU PAYSAGE  
Aquitaine

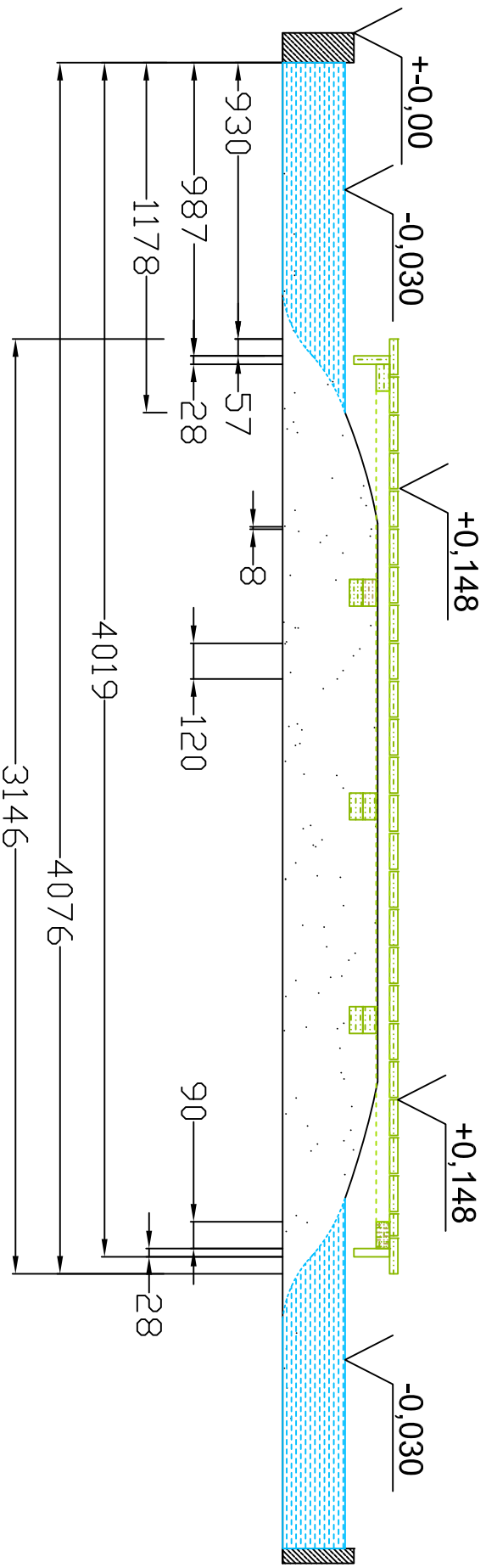

-COUPE CC'

INDICE 7

07 - 11- 2016

**Olympiades Nationales Bordeaux 2017**  
**- Jardiniers Paysagistes -**

Unités: Plan / mm - Altimétrique / ml







-COUPE DD' -

INDICE 7      07 - 11- 2016

**Olympiades Nationales Bordeaux 2017**  
**- Jardiniers Paysagistes -**



Unités: Plan / mm - Altimétrique / ml

chaque jardin compte

LES ENTREPRISES DU PAYSAGE  
Aquitaine



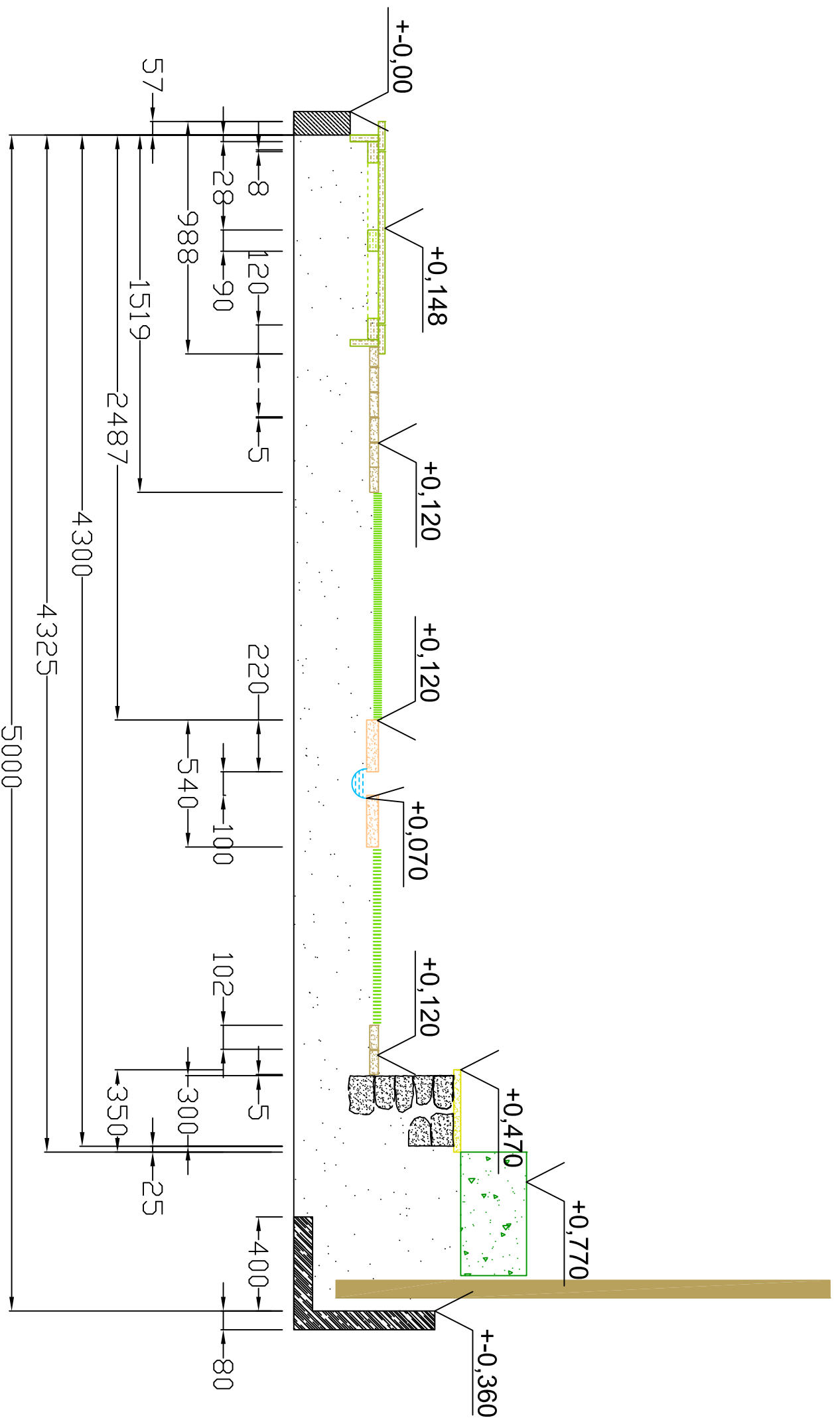

-COUPE EE' -

INDICE 7

07 - 11 - 2016



Unités: Plan / mm - Altimétrique / ml



Olympiades Nationales Bordeaux 2017

- Jardiniers Paysagistes -